

BURNER REPLACEMENT PARTS COMPATIBLE WITH BABCOCK POWER (RILEY) BOILERS

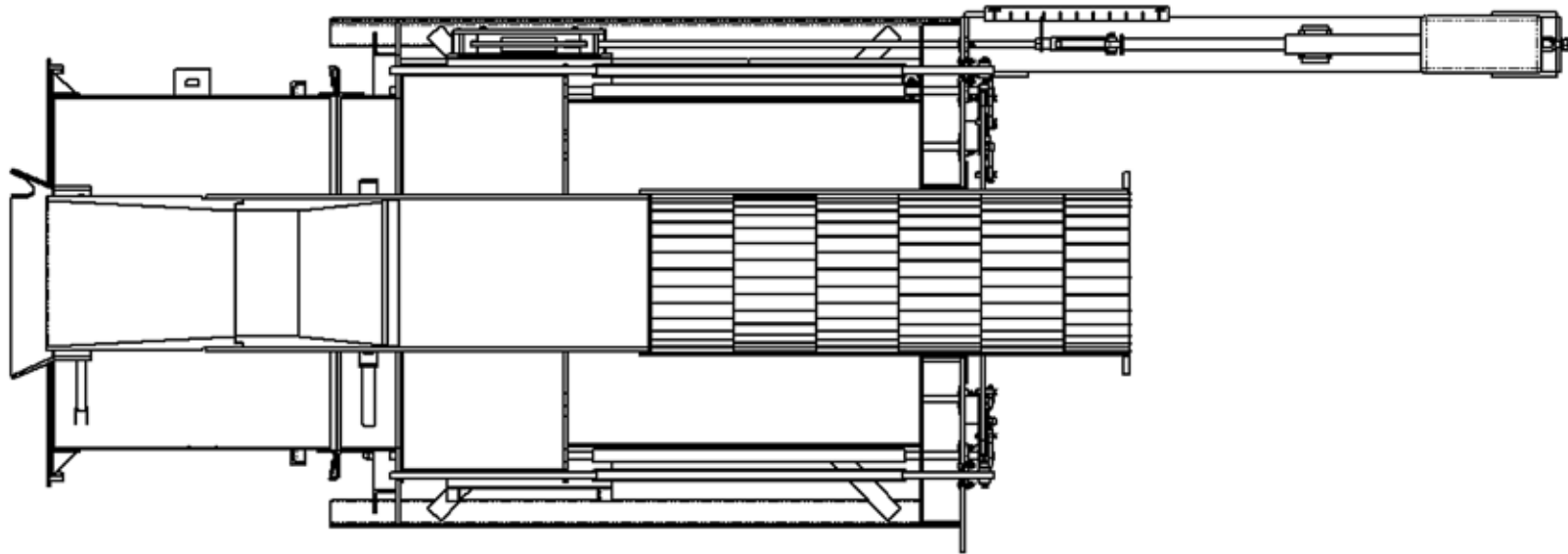

- **Coal Headers**
- **Coal Spreaders**
- **Primary Air Vanes**
- **Control Rods**
- **Coal Nozzles**
- **Protector Sleeves**
- **Venturi Diffusers**
- **Flame Stabilizers**

**POWER & INDUSTRIAL SERVICES HAS NO AFFILIATION WITH BABCOCK POWER.
POWER & INDUSTRIAL SERVICES CORPORATION MANUFACTURES THESE IMPROVED REPLACEMENT PARTS WHICH ARE COMPATIBLE WITH BABCOCK POWER BOILERS**

REPLACEMENT PARTS COMPATIBLE WITH BABCOCK POWER BOILERS

- *COAL HEADERS* • *COAL NOZZLES*

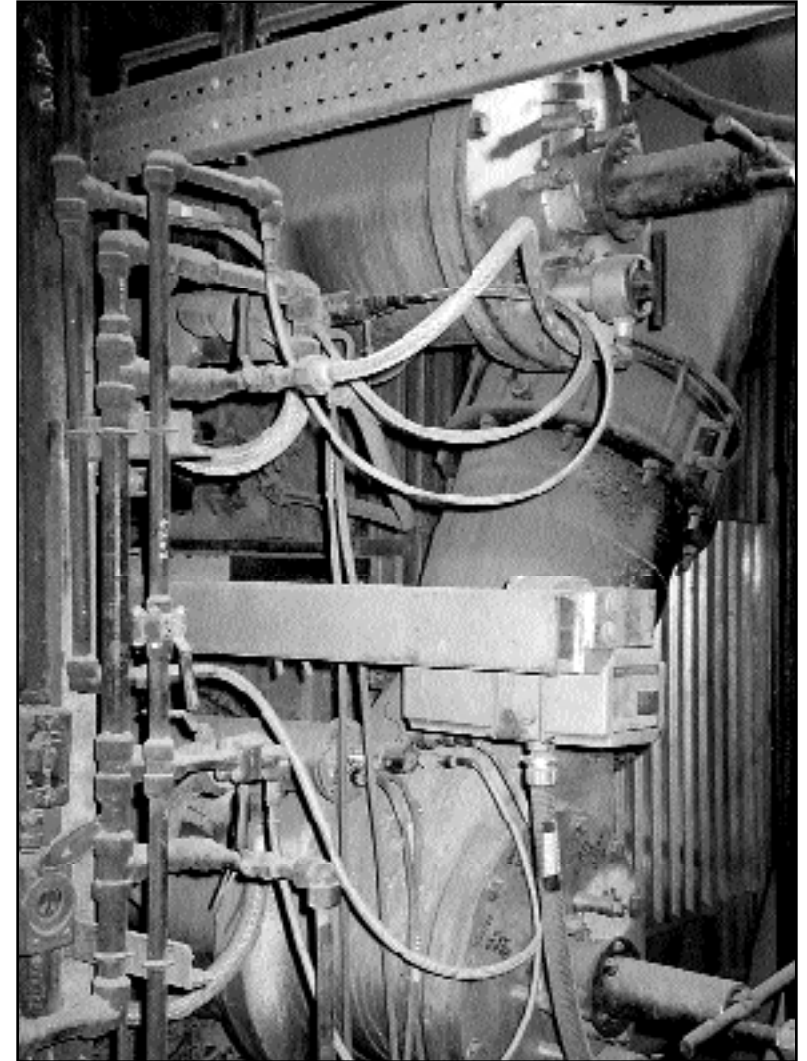
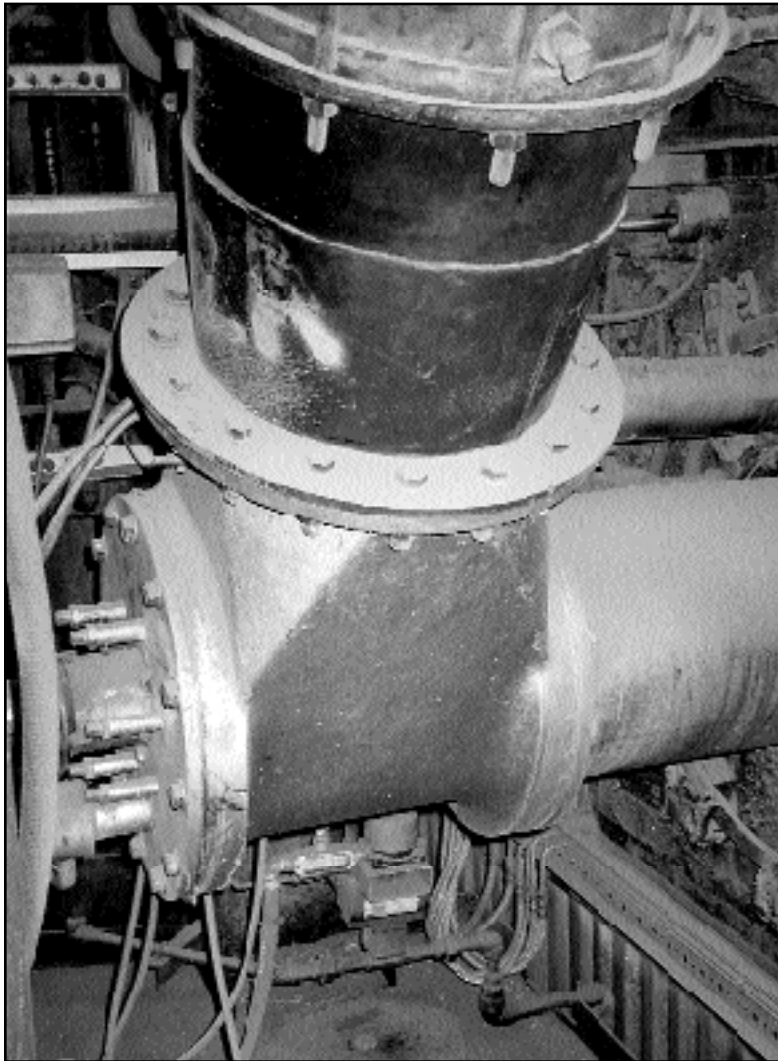

REPLACEMENT PARTS COMPATIBLE WITH BABCOCK POWER BOILERS

COAL HEADER VANES



NI HARD PRIMARY AIR VANES

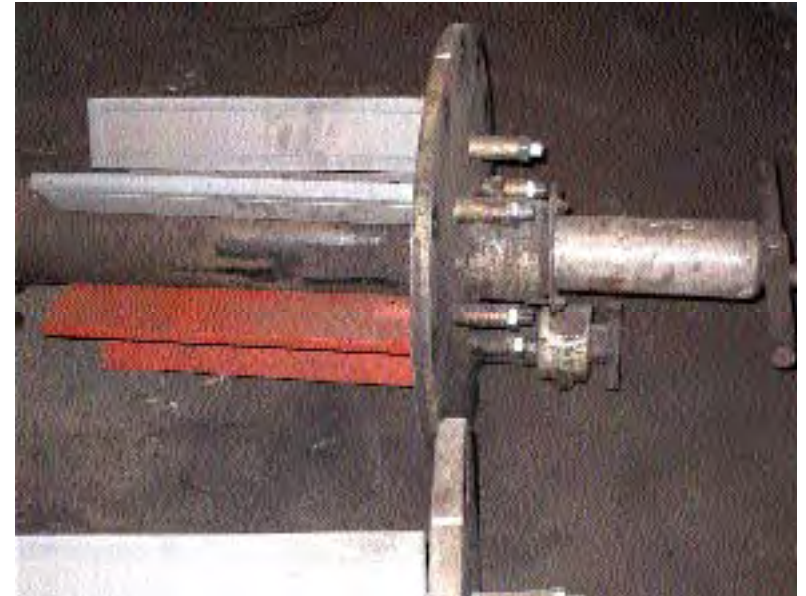

PRIMARY AIR VANE ASSEMBLY



SILICON CARBIDE PRIMARY AIR VANES



REPLACEMENT PARTS COMPATIBLE WITH BABCOCK POWER BOILERS

**COAL
NOZZLES**

CERAMIC LINED COAL NOZZLE

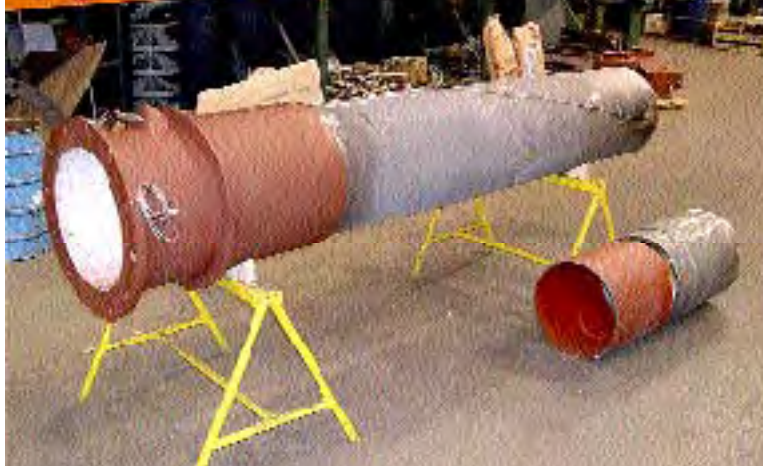

VENTURI DIFFUSERS NIHARD/PI-2000

COAL NOZZLE ID VIEW



COAL NOZZLE WITH THERMOCOU-

REPLACEMENT PARTS COMPATIBLE WITH BABCOCK POWER BOILERS AIR REGISTERS



REPLACEMENT PARTS COMPATIBLE WITH BABCOCK POWER BOILERS SWIRLERS AND COAL SPREADERS

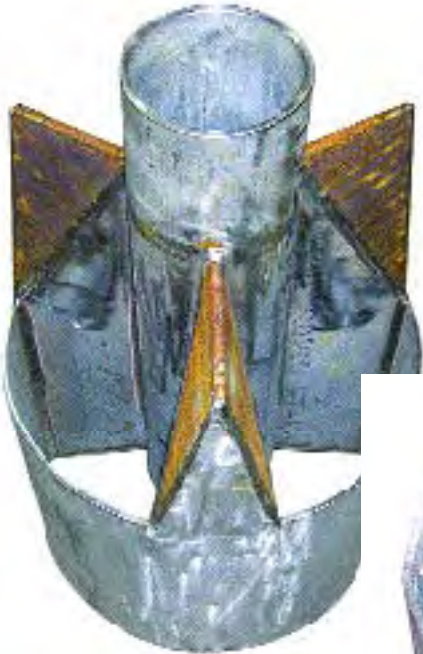

FABRICATED



CAST PI-2000

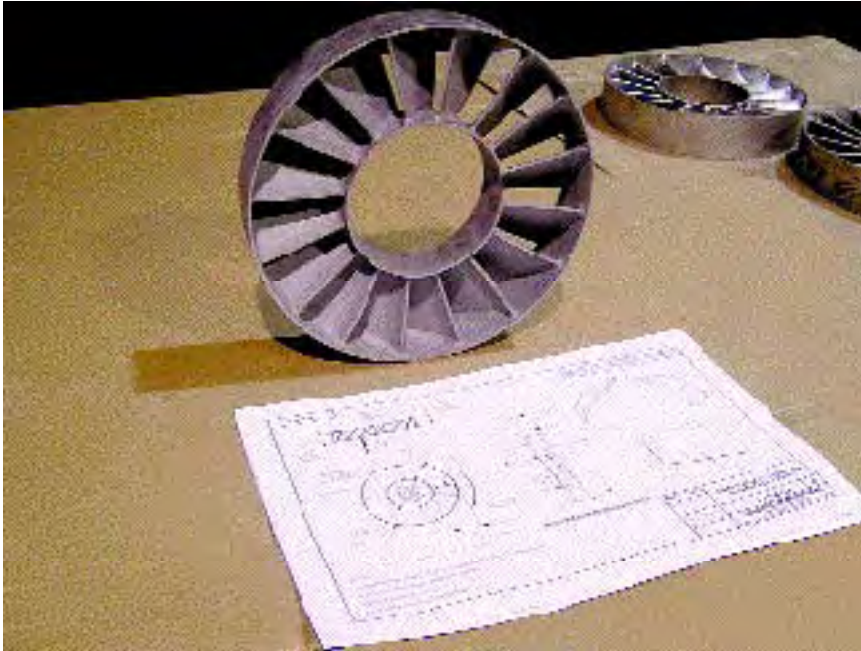

REPLACEMENT PARTS COMPATIBLE WITH BABCOCK POWER BOILERS COAL SPREADERS AND FLAME STABILIZERS

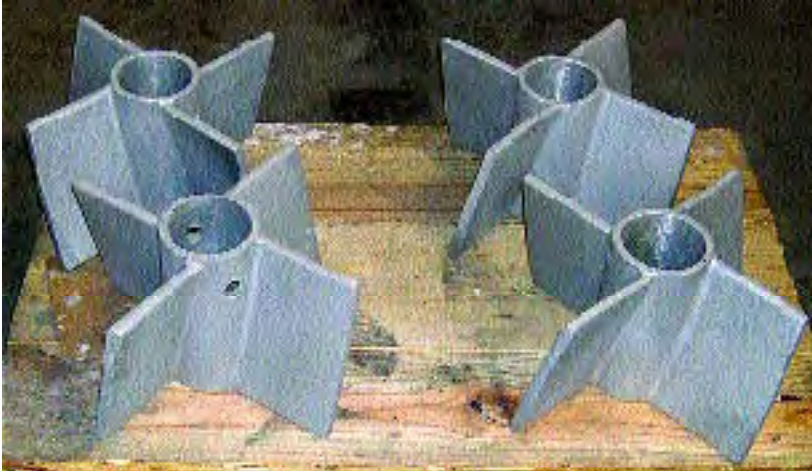

Coal Spreader

- **Tungston Carbide/Titanium Coated Stainless Steel**
- **50/50**
- **Spreader Control Rod Assemblies
309 Stainless Steel—All Sizes**
- **Protective Sleeves For Control Rod**

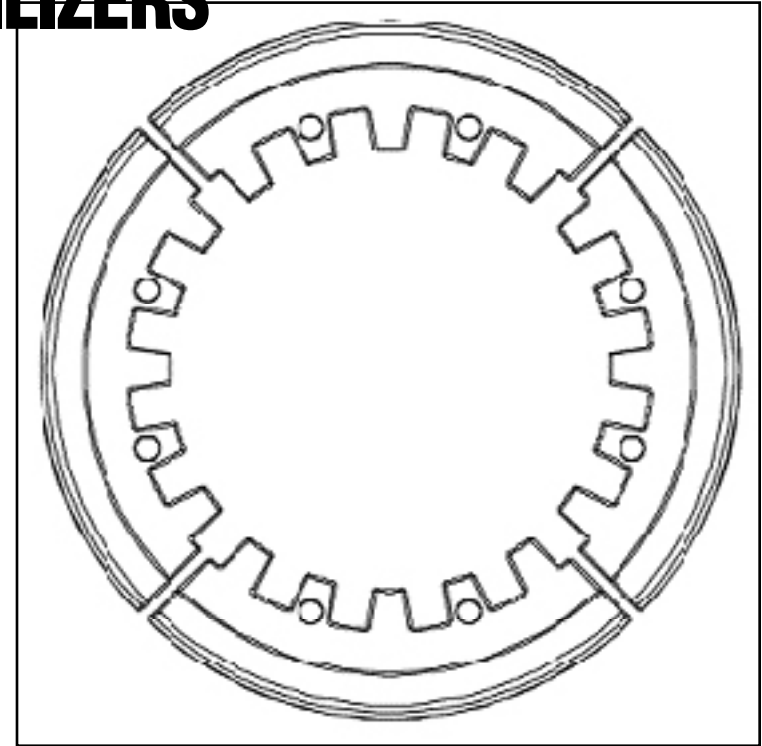

Flame Stabilizers



- **NiHard (Shown)**
- **Silicon Carbide**

REPLACEMENT PARTS COMPATIBLE WITH BABCOCK POWER BOILERS TURBO FURNACE REPLACEMENT PARTS

PANT LEG BURNERS

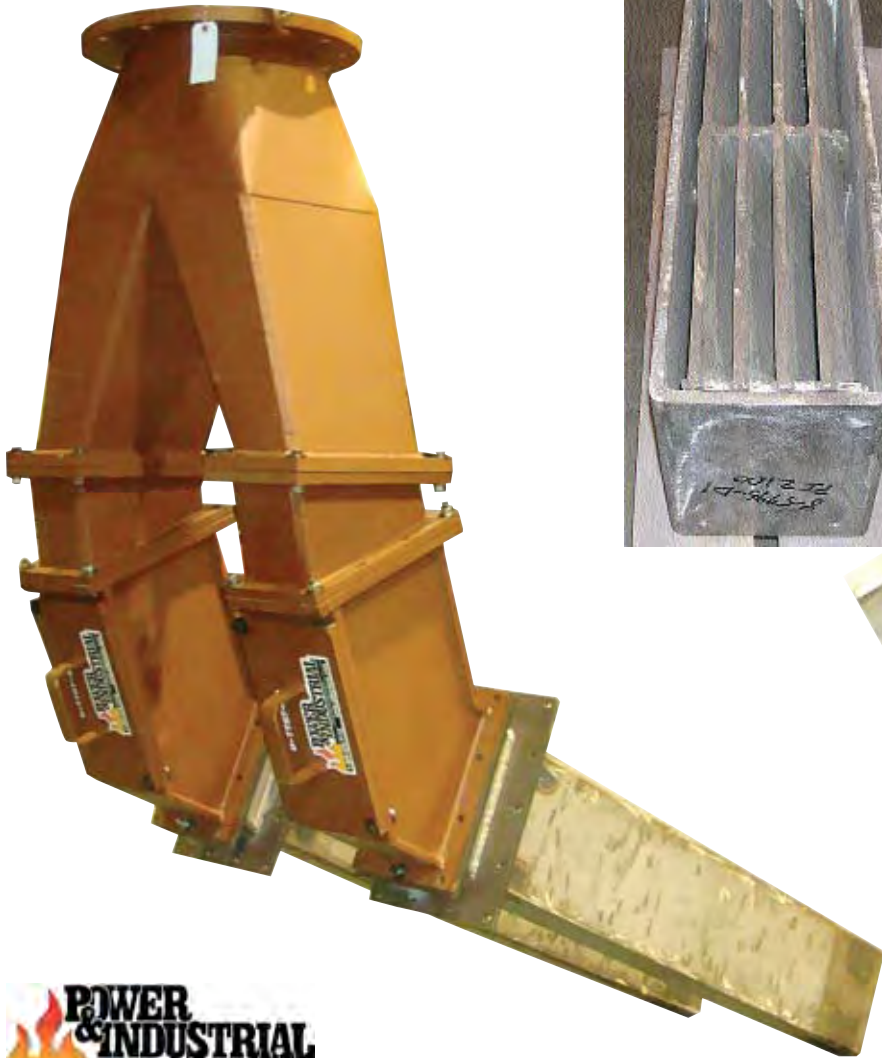

*Cast
PI-2000 Tips*

